

TECHNICAL DATA SHEET

PRODUCT	PU-AZ-1-26H-N*-L**/options	
SERIES	AZ-1 Single Acting Air operated, hydraulic pumps for pressure testing, chemical injection and hydraulic power.	

FEATURES

- Infinitely variable output pressure and flow
- Will hold static pressure without generating heat or consuming power
- Standard models are suitable for oil or water applications
- Well proven and trouble-free operation

PERFORMANCE DATA

Max Rated Output Pressure	2,625psi (181bar)
Output Per Cycle	0.98 in ³ (16cc)
Max Flow	537 in ³ /min (8.8 litre/min)
Max Air Supply Pressure	100psi (7bar)
Ratio	26 : 1
Air Consumption	28 scfm (800 NI/min)

SEAL OPTIONS (N*)

N* (standard)	Nitrile (Buna-N) Main Seal and Check Valve Seals
V	Viton (FKM) Main Seal and Check Valve Seals
C	Chemraz (FFKM) Main Seal and Check Valve Seals

CONSTRUCTION

Air Motor	Anodised Aluminium / Wound Composite / Nitrile (Buna-N) Seals
-----------	---

Hydraulic Cylinder	Stainless Steel
Piston	Stainless Steel + Chrome Finish
Check Valves	Stainless Steel (Seals as per Selected Seal Option)
L1** (standard)	Plated Steel Air Motor Studs
L2** (optional)	Stainless Steel Air Motor Studs

CONNECTIONS

Hydraulic Inlet	1/2"NPT(F)
Hydraulic Outlet	1/2" NPT(F)
Air Inlet	1/2" NPT(F)
Silencer Air Outlet	3/4"NPT(F)
Net Weight	7kg (15.5lb)

COMMON OPTIONS (BUT NOT LIMITED TO)

/ A	ATEX (94/9/EC) II 2GD c T5
/ L	Low pressure start for air motor
/ N	Greased for life lubricated air motor

GENERAL LAYOUT DRAWING

Model: **PU-AZ-1-26H**

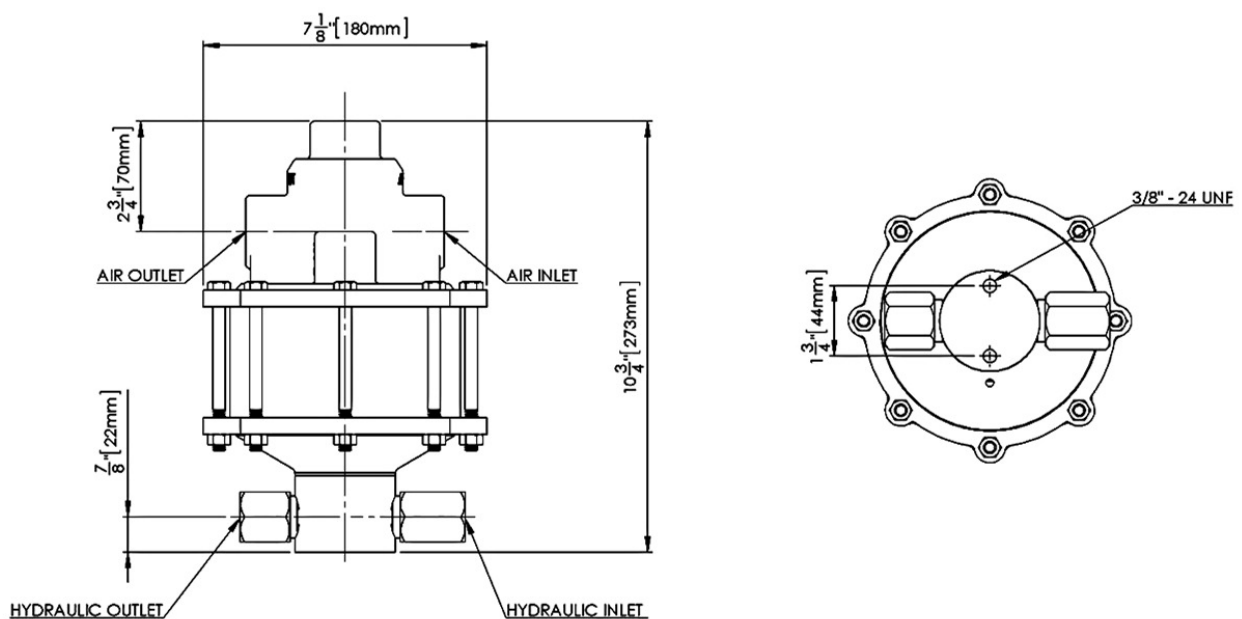

HYDRAULIC PRESSURE STATIC / STALL CONDITIONS

AIR PRESSURE	HYDRAULIC PRESSURE
20psi (1.4bar)	475psi (33bar)
40psi (2.8bar)	1,000psi (69bar)
60psi (4bar)	1,550psi (107bar)
80psi (5.5bar)	2,000psi (138bar)
100psi (7bar)	2,625psi (181bar)

FLOW CURVE

AZ-1-26 - Ratio 26:1

